

# Implicit Neural Representation as a Differentiable Surrogate for Photon Propagation in a Monolithic Neutrino Detector

Patrick TSANG (SLAC)

Aug 7, 2023

US-Japan Neutrino AI/ML Kick-off Meeting

# Liquid Argon Time Projection Chamber (LArTPC)

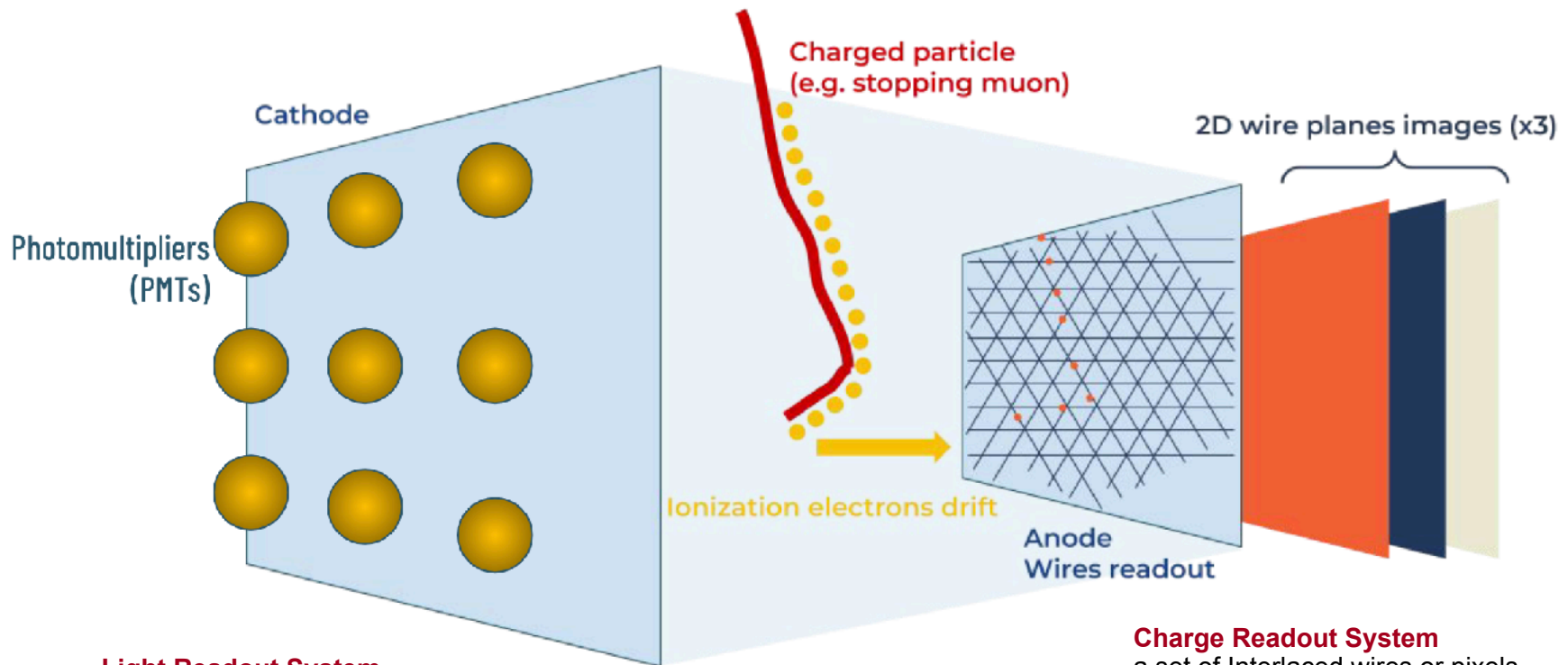

**Light Readout System**

detection of scintillating photons at O(ns)



**Charge Readout System**

a set of Interlaced wires or pixels  
drift time O(ms)

$$\text{Drift distance} = \text{Drift Velocity} * (t - t_0)$$

# Examples of LArTPC Detectors

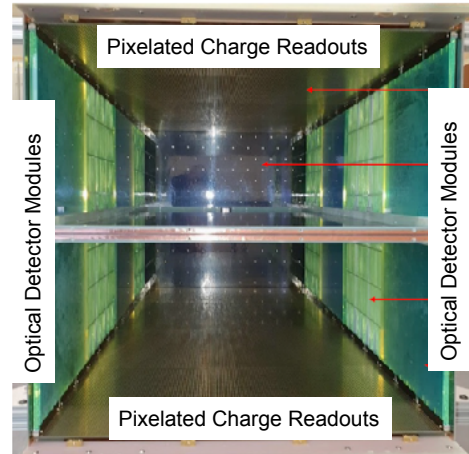
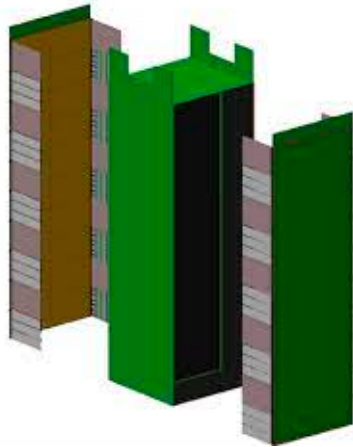

## Module-0 Demonstrator

- 1st ton-scale prototype of DUNE\* near detector design
- ~0.7 m x 0.7 m x 1.4 m
- divided into 2 TPCs
- pixelated charge readout
- 2 different optical detector prototypes: LCM & ArcLight



## ICARUS\*\*

- largest LArTPC in operation with wire readout
- 760 ton LAr in 2 TPCs
- each ~3.6 m x 3.9 m x 19.9 m

\*DUNE: Deep Underground Neutrino Experiment

\*\*ICARUS: Imaging Cosmic And Rare Underground Signals

# Proposed LArTPC Detectors

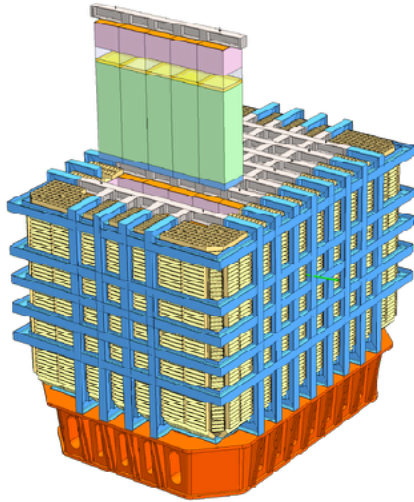

## DUNE Near Detector-Liquid Argon (ND-LAr)

- 7x5 array of 1 m x 1m x 3m detector modules (similar design as module-0 demonstrator)
- ~67 ton of LAr

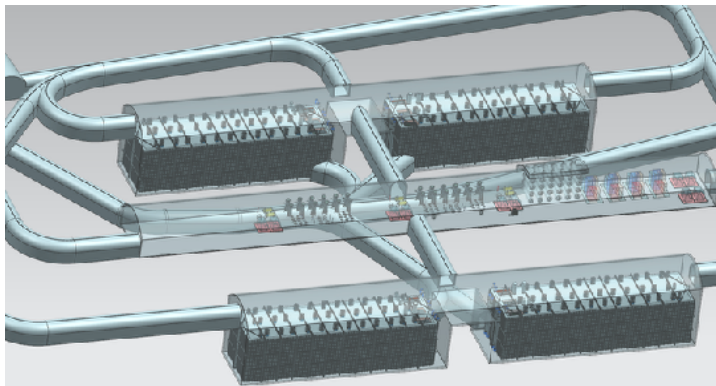

## DUNE Far Detector

- 4 x ~17-kton detector modules
- each ~19 m x 18 m x 66 m

*Scalability* is the key for the future

# Scintillation Light Propagation Model Lookup Table (LUT) Approach

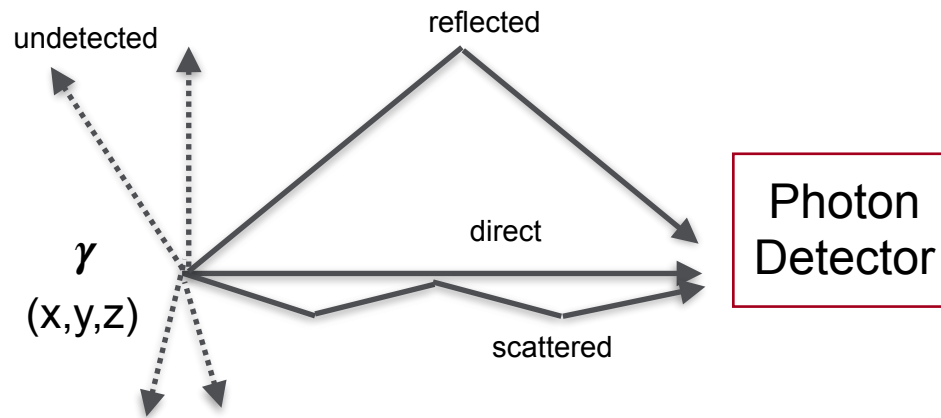

## Visibility Lookup Table

- divide the detector volume into voxels of  $\sim$ cm in size
- for each voxel, simulate and propagate millions of photons
- count the number of detected photons
- visibility at  $(x,y,z) = \#$  detected photons /  $\#$  generated photons

- Limited by memory usage
- Not scalable for large detector
- Simulation-based, difficult to calibrate

# Sinusoidal Representation Network (SIREN)

## Implicit Neural Representation

Parameterize signals as *continuous* functions via *neural networks*, which are trained to map the domain the signal (e.g. spatial coordinates) to the target outputs (e.g. signal at those coordinates).

$$f: \mathbb{R}^M \rightarrow \mathbb{R}^N$$

## SIREN

a simple multilayer perceptron (MLP) network architecture along with periodic *sine* function activations (Sitzmann et al., [arXiv:2006.09661](https://arxiv.org/abs/2006.09661))

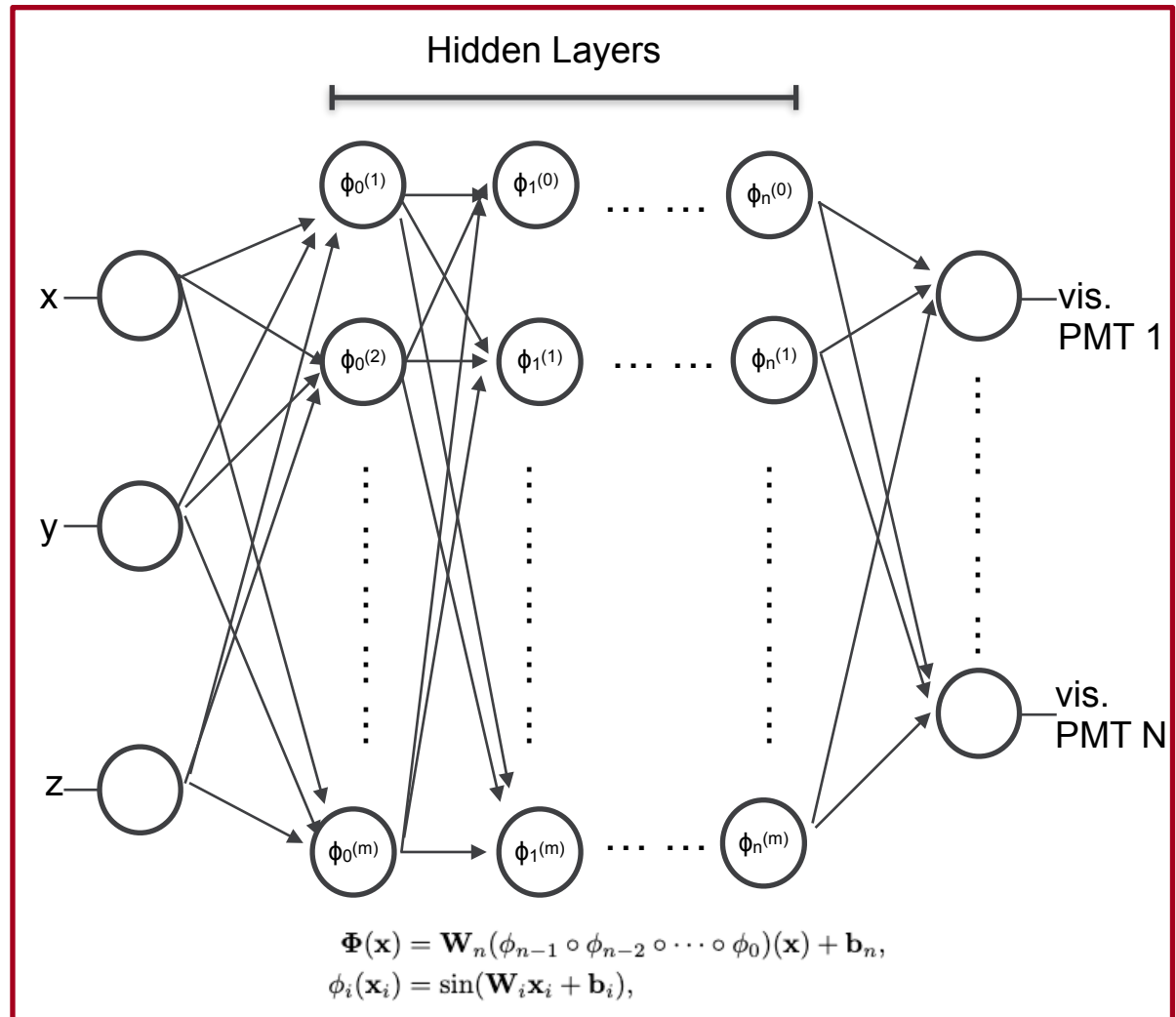



# Why SIREN?

By construction, SIREN is a continuous, differentiable signal representations  
=> modeling signals with fine detail, AND  
=> representing smooth gradient surface (and higher order of derivatives)

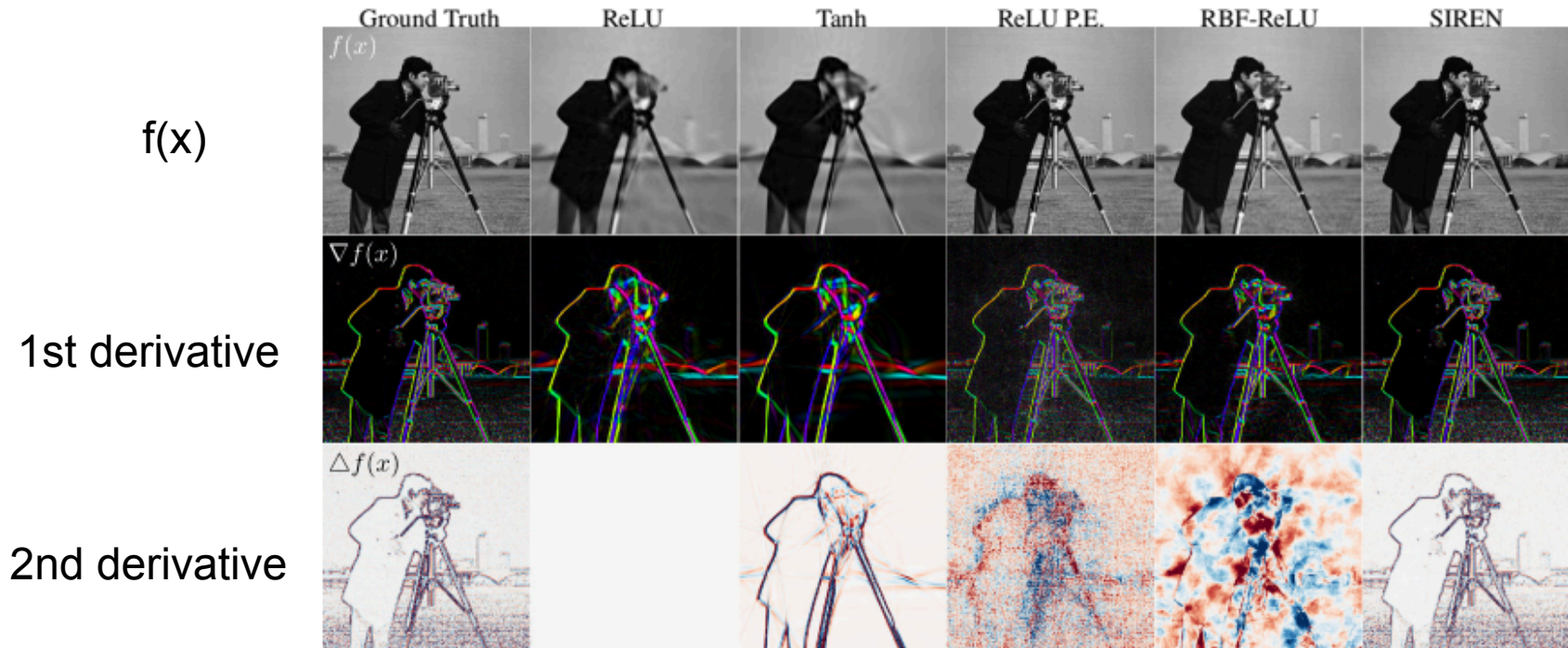

SIREN ([arXiv:2006.09661](https://arxiv.org/abs/2006.09661))

Allows wide range of applications from gradient-based algorithms, solving differential equation, optimizing on the derivative ... etc

# Visibility: SIREN v.s. LUT

ICARUS Simulation  
Visibility at  $x = -362.5$  cm

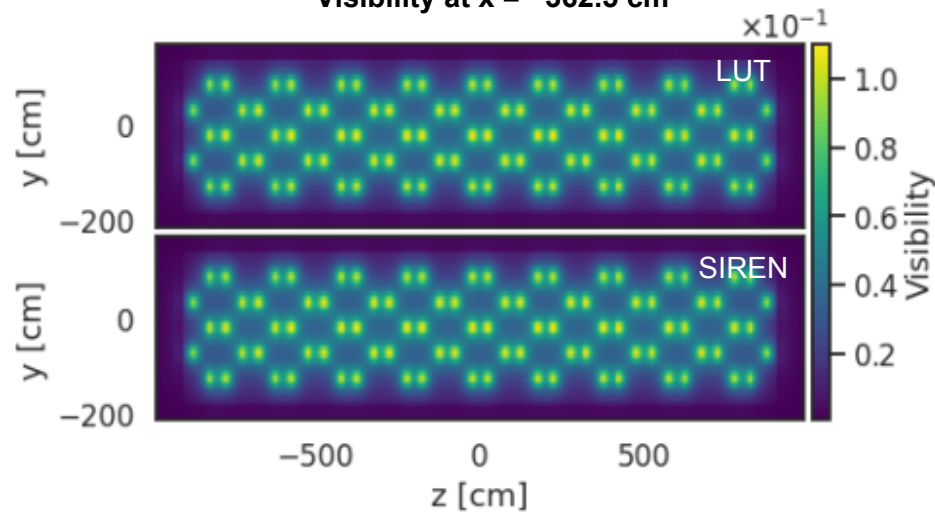

## LUT (top)

- $74 \times 77 \times 394 = 2.2$  M voxels (5 cm in size)
- 180 PMTs =  $\sim 404$  M parameters

## SIREN (bottom)

- 5 hidden layers, 512 hidden features
- $\sim 1.5$  M parameters

Visibility Gradient  
PMT#63 at  $x = -362.5$  cm

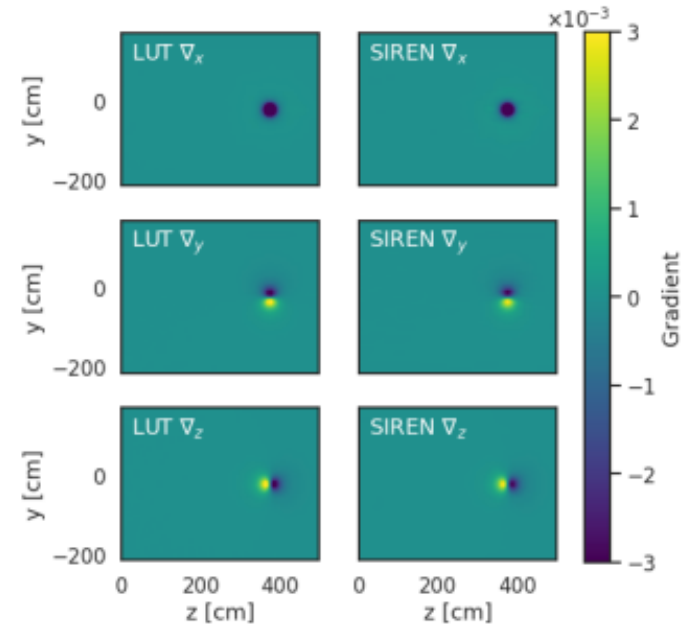

SIREN can reproduce both values and gradients of the visibility LUT with much smaller number of parameters.



# Application of SIREN to Data Charge-to-Light Prediction

3D Image of an anode-cathode crossing track from charge readout

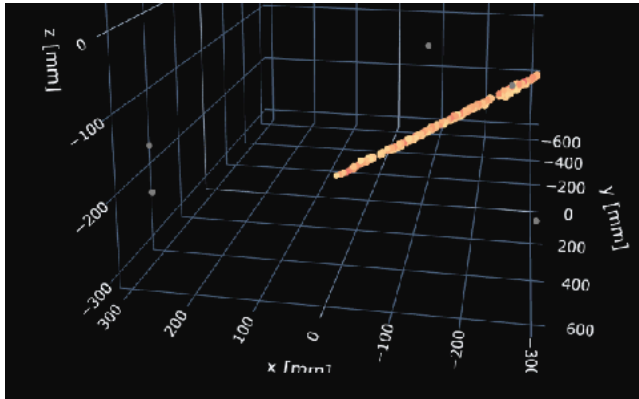

$$\text{Light Signal} \sim \sum Q_i * \text{vis}(r_i)$$

Sum charge ( $Q_i$ ) over the track image

visibility at charge coordinates  $r_i$



Observed and Predicted Light Signal

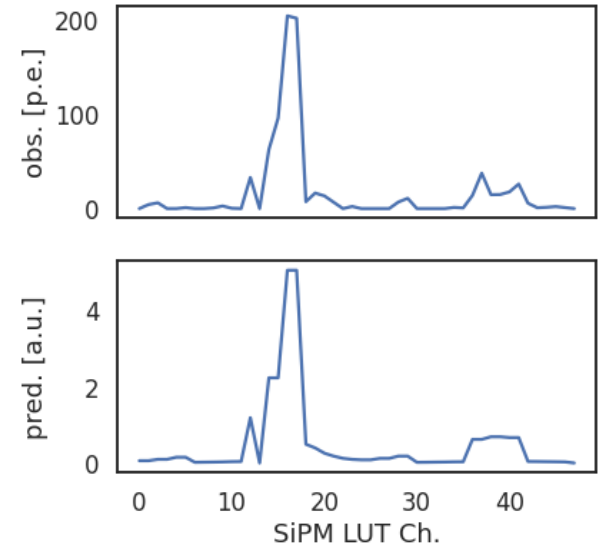

- point-like source, i.e. visibility at (x,y,z), is not accessible in data
- infer light signal from physics objects (e.g. tracks)

## Optimize SIREN parameters using track data

For the rest of the talk, I will show some real world applications of SIREN using cosmic rays data from *Module-0 Demonstrator*.

Poisson Likelihood

$$\mathcal{L}_{\text{track}} = \prod_{j=1}^N \text{Pois}(n_j | \lambda_j)$$

product of all PMTs

Observed p.e. for j-th PMT

Predicted light signal

# Module-0: SIREN from Simulation

## Module-0 Demonstrator SIREN from Simulation (LUT)

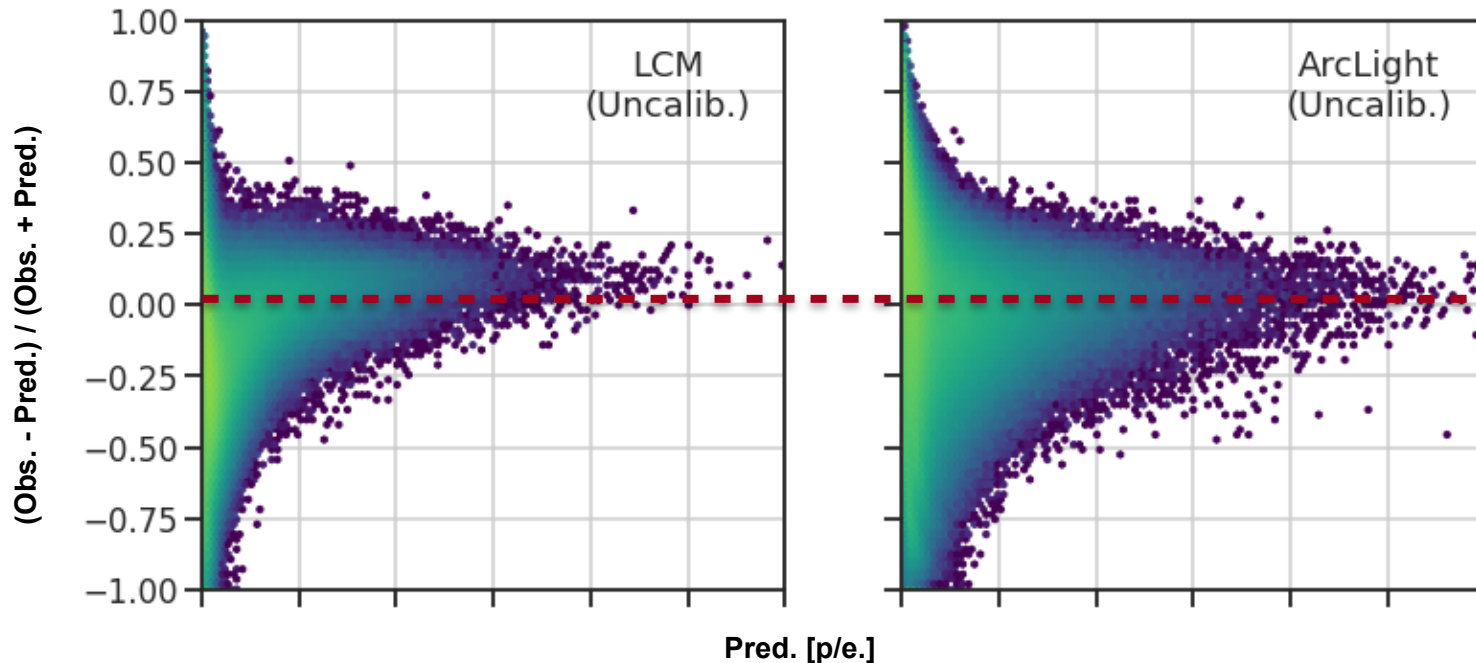

### Before Calibration

- train SIREN with LUT from simulation (uncalibrated)
- ~10% discrepancy between observed and predicted light signals

Simulation is reasonable, but not perfect. Need calibration.

# Module-0: SIREN after Calibration

## Module-0 Demonstrator SIREN with Data Calibration

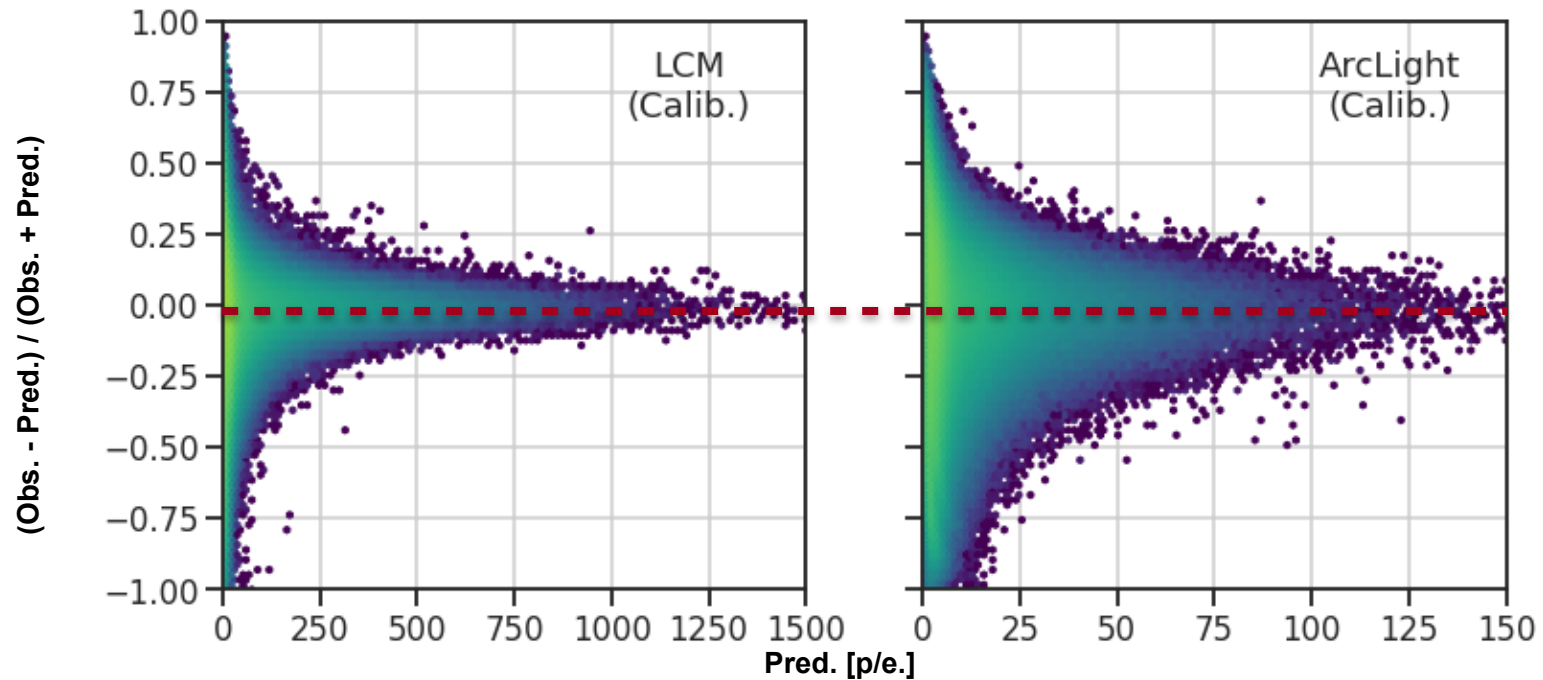

### After Calibration

- re-optimize SIREN parameters with tracks
- no bias and smaller variance

SIREN can be calibrated to remove data-simulation discrepancy.

# Build a SIREN Model Directly from Data

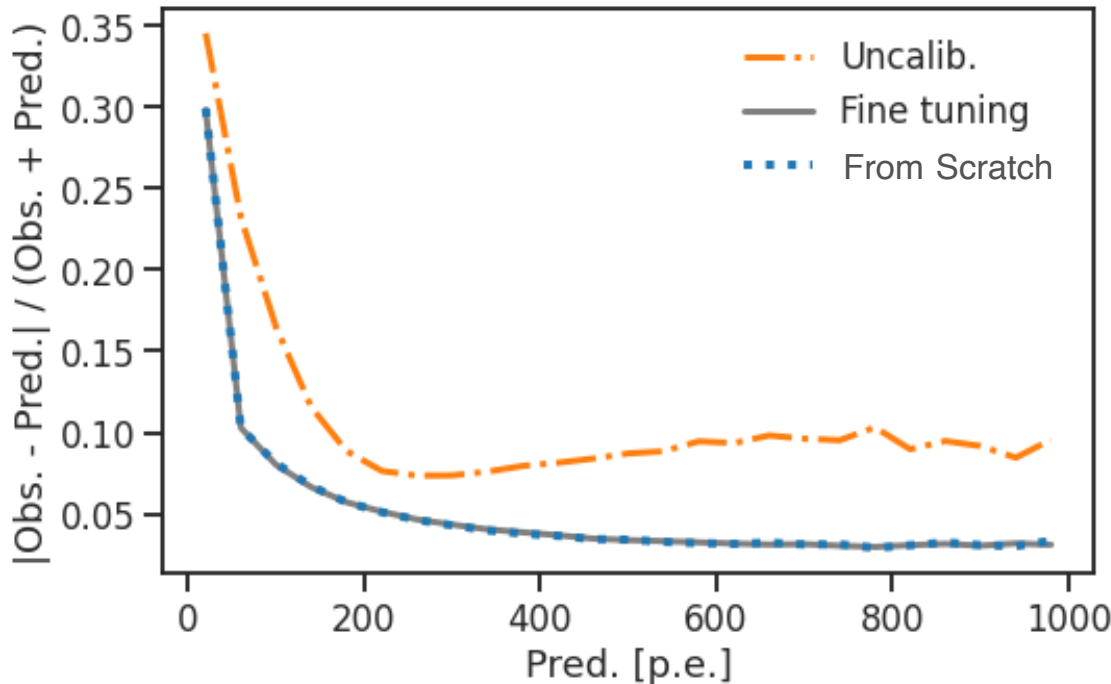

## Uncalibrated

- SIREN trained from LUT (simulation)
- suffer from data-MC discrepancy

## Fine Tuning

- use uncalib. SIREN model as initial parameters
- re-optimize with tracks (calibration)

## From Scratch

- random initialization of SIREN parameters
- optimize with tracks

SIREN model can be constructed from data alone, without prior knowledge from simulation.

# Example Events

Only one chamber TPC-0 is presented in this study.  
Grayed out points (unclustered or in TPC-1) are excluded.

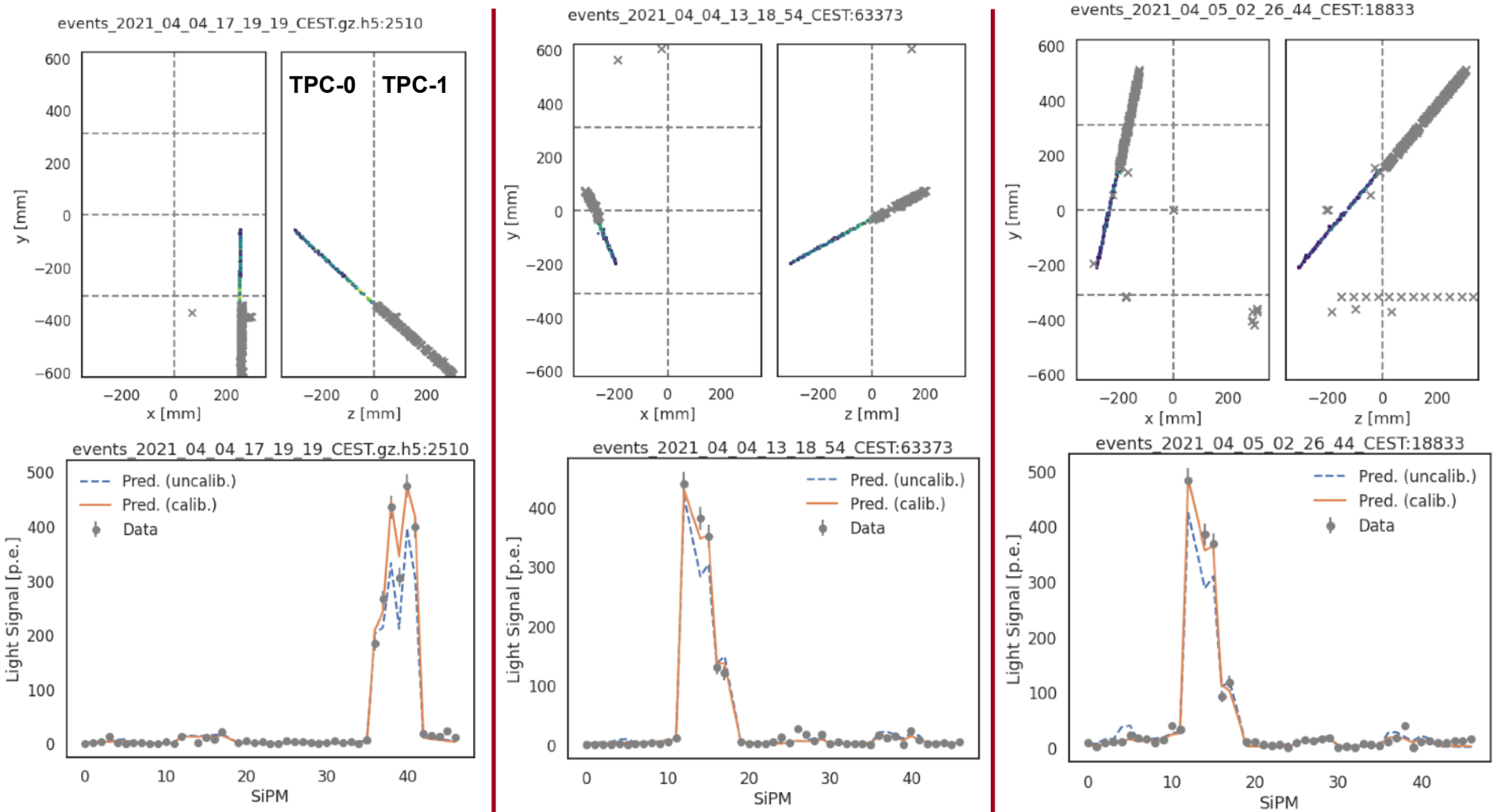

**Better agreement after calibration.**

# Visibility Map (LCM)

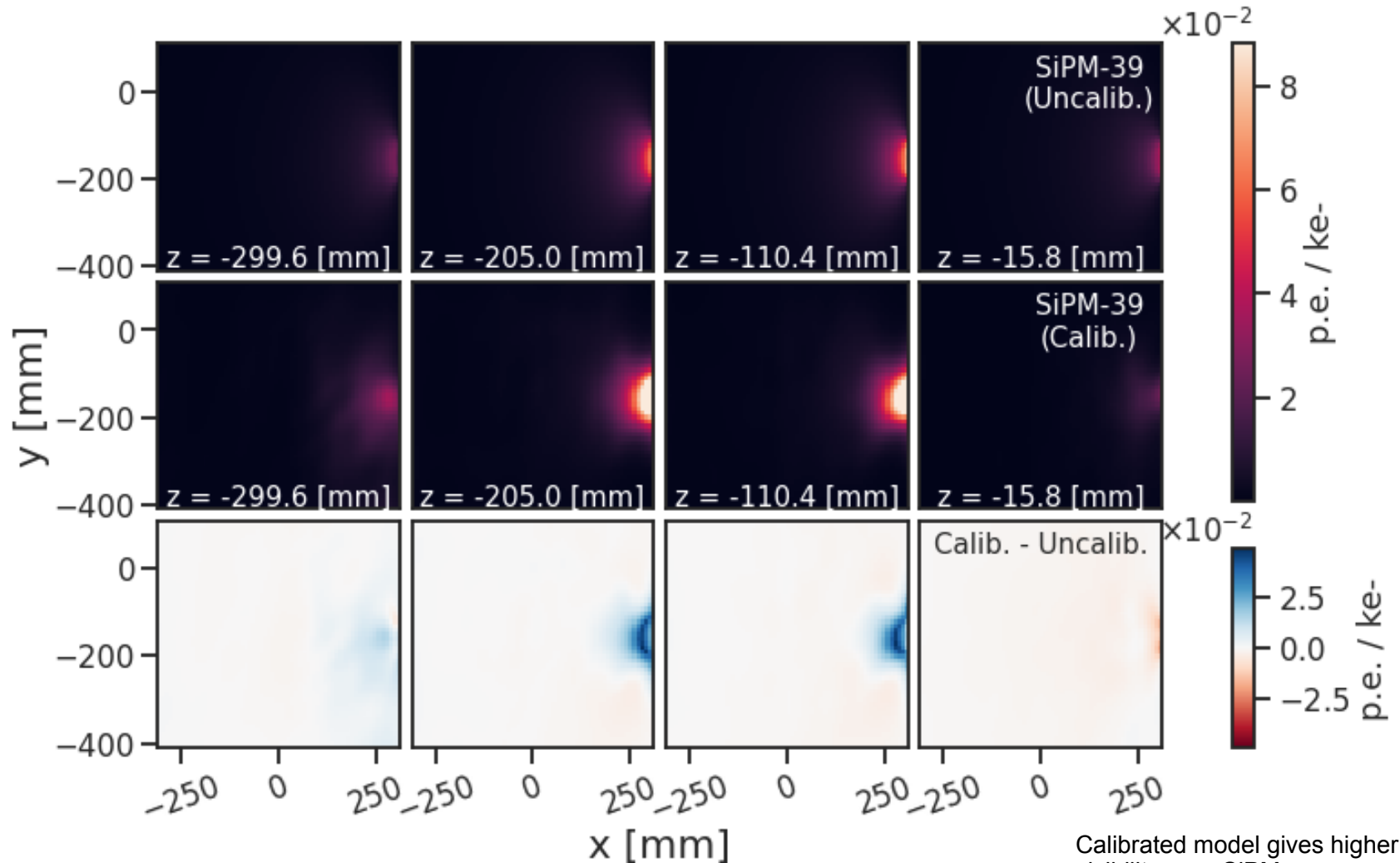

Calibrated model gives higher visibility near SiPM.



# Visibility Map (ArcLight)

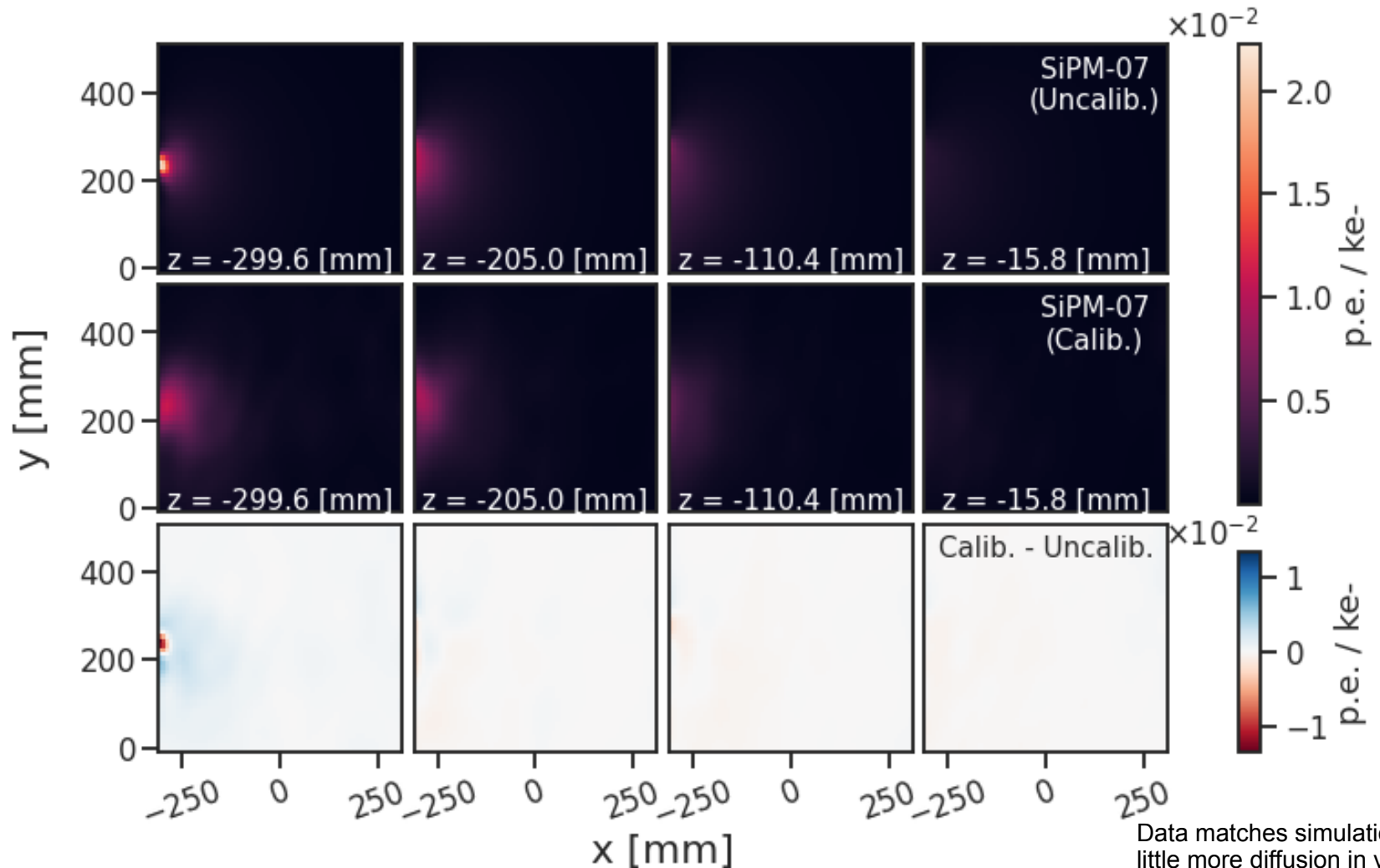

Data matches simulation, with a little more diffusion in visibility.

May provide useful insights for detector R&D.

# Hyper-Parameter Optimization

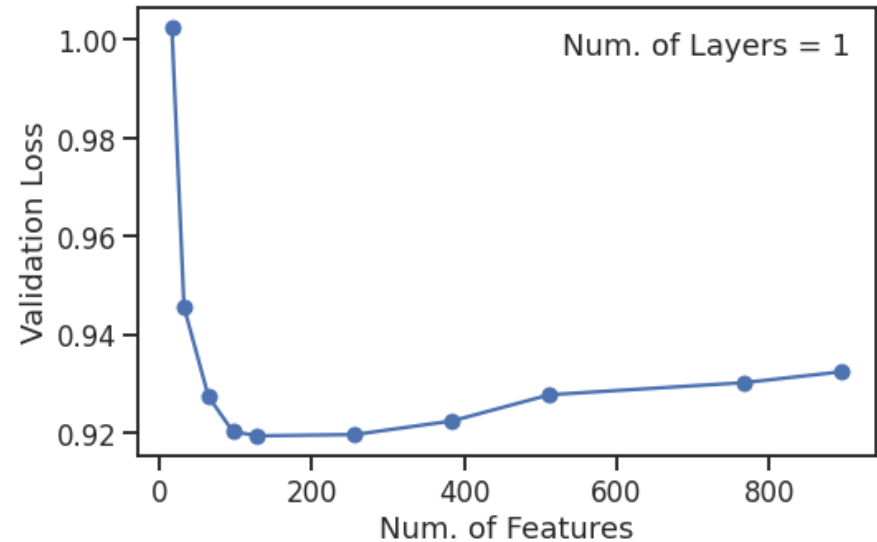
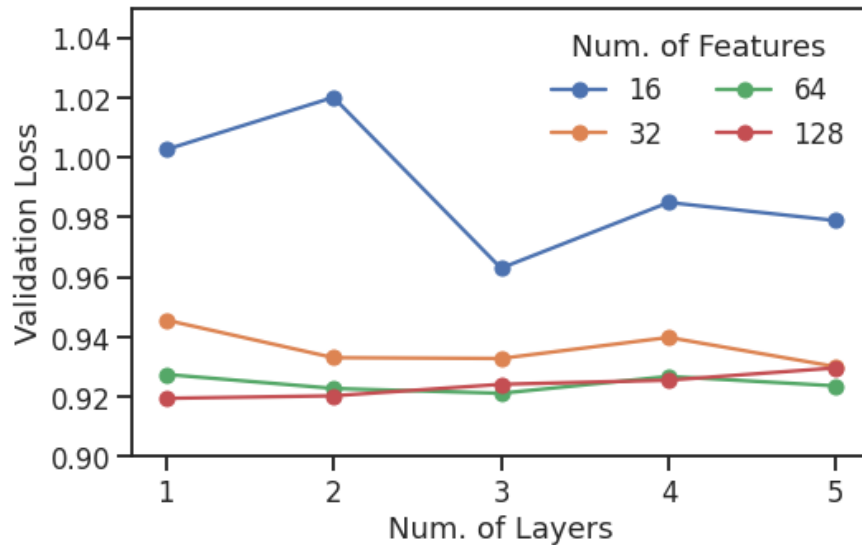

## Optimal SIREN model for module-0 demonstrator

- determined by track data
- # of layers = 1
- # of features = 128
- ~23k parameters
- c.f. 12.6M for LUT in ~1 cm voxel size

# How Many Tracks Needed?

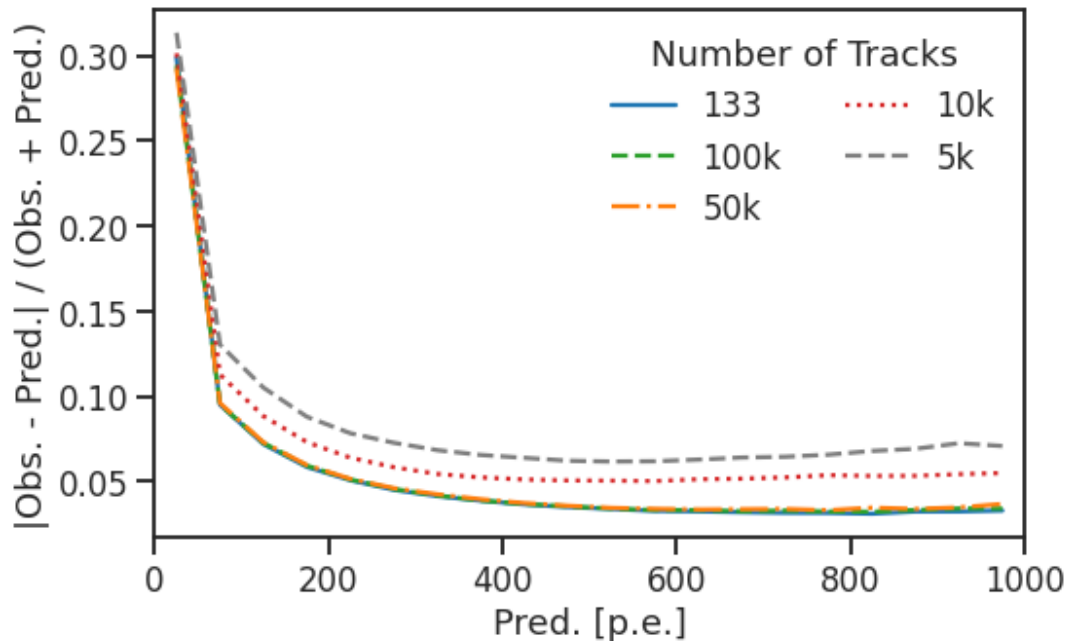

- performance increase significantly from 5k to 50k tracks
- difference diminishes to  $\sim 0.1\%$  from 50k and beyond
- $\sim 100k$  tracks are good enough to build a SIREN model for Module-0 demonstrator

- propose the use of sinusoidal representation network (**SIREN**) to model the light propagation for LArTPCs
  - memory efficient => scalable for large detectors
  - optimizable w/ data => calibration
  - smooth gradient surface => further applications
- optimize a SIREN model using data from Module-0 demonstrator
  - fine-tuning from a simulation-based SIREN model,
  - or construct a SIREN model from data only.
- potential applications to other experiments (not limited to LArTPC)

**Backup Slides**

# SIREN Performance

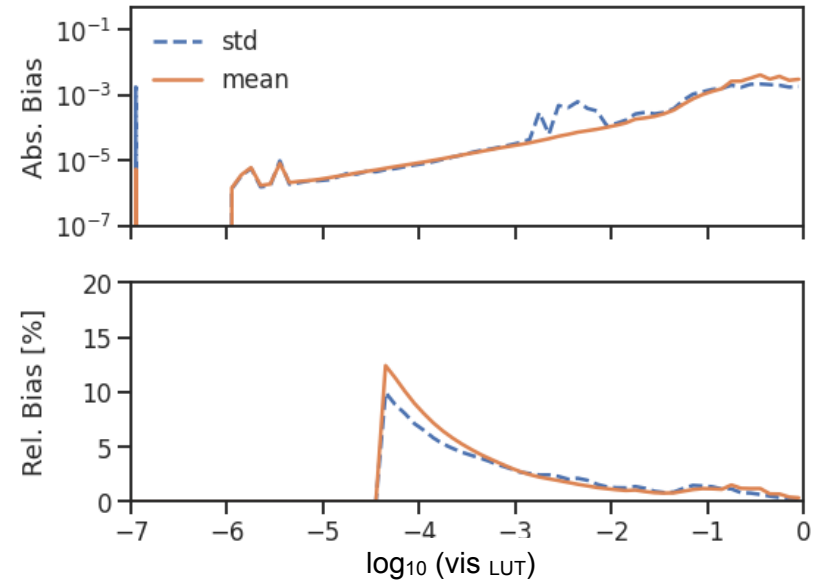
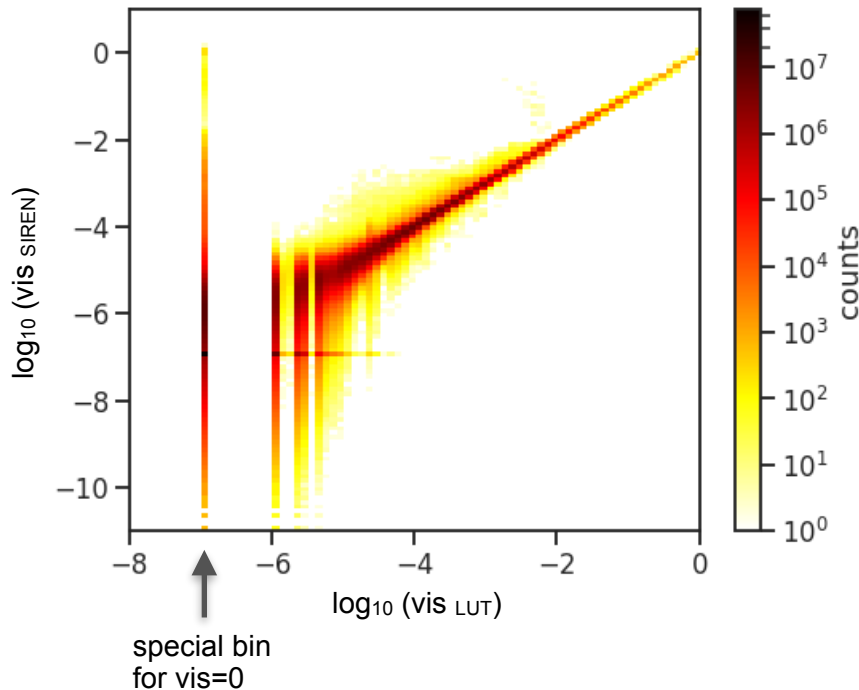

SIREN is able to represent LUT with  $\sim 1\%$  in the high visibility region ( $\text{vis.} > 1e-2$ ).

The overall (average) bias is  $\sim 7-8\%$ , which is dominated by the statistical fluctuation of the LUT at low visibility.



# Statistical Uncertainty in LUT

Generation of the photon library is limited by *finite statistics*.

The input data to the SIREN are subjected to *statistical uncertainty* (more prominent for voxels with low visibility).

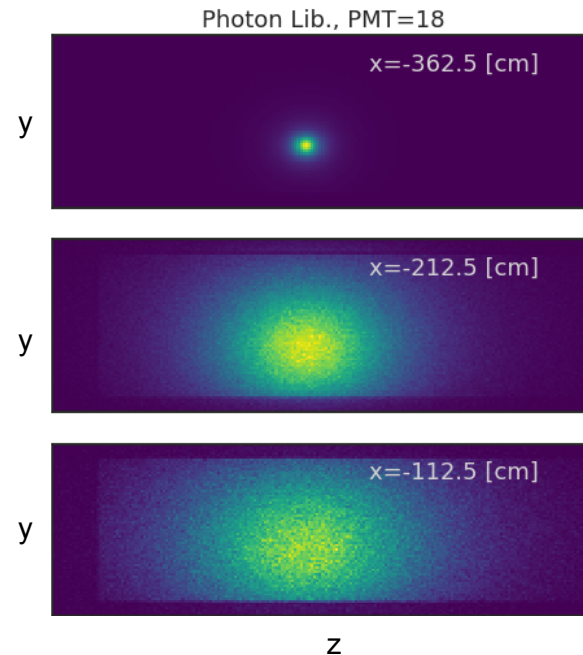

# Toy Model: A Study w/ and /o Stat. Err.

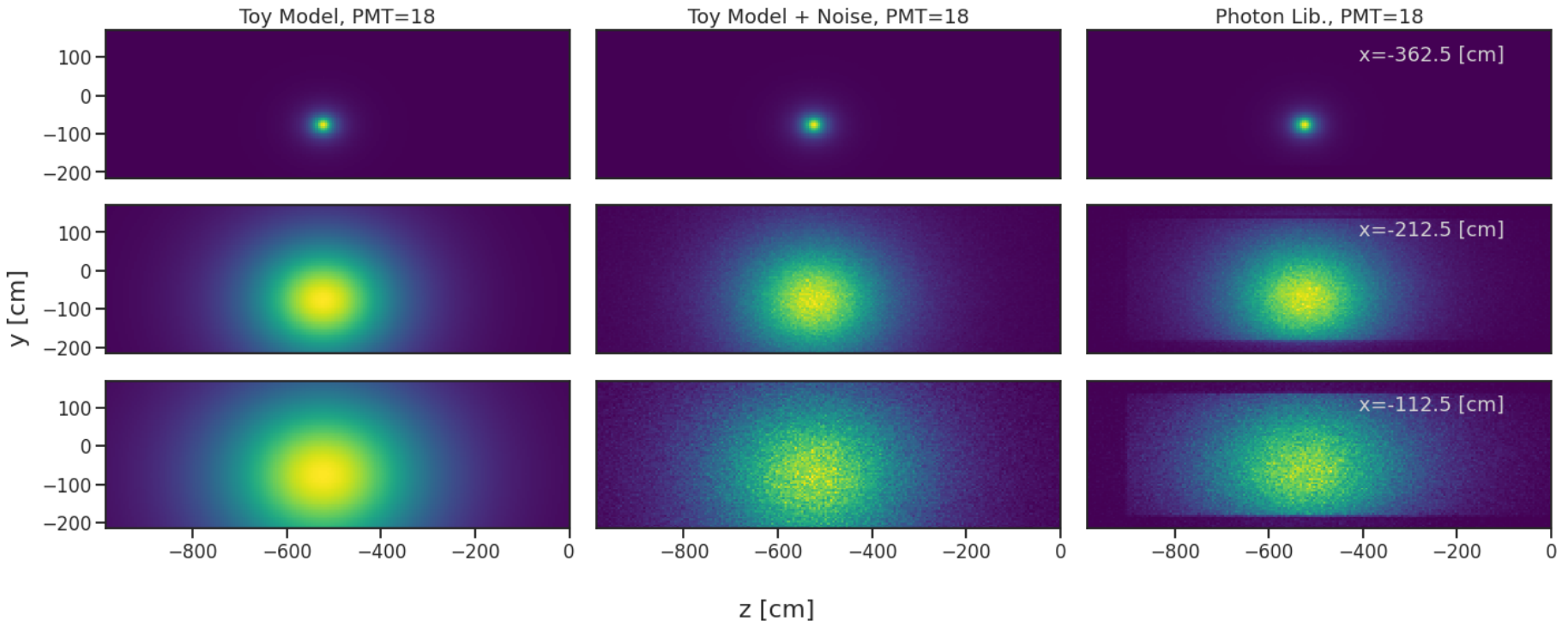

**Toy Model:** analytical (smooth) model that roughly reassemble the features of LUT.  
No statistical fluctuation.

**Toy Model + Noise:** sampling from toy model, assuming 1e6 photons per voxel,  
~same statistical uncertainty as the LUT.

# SIREN Performance w/o Statistical Uncertainty

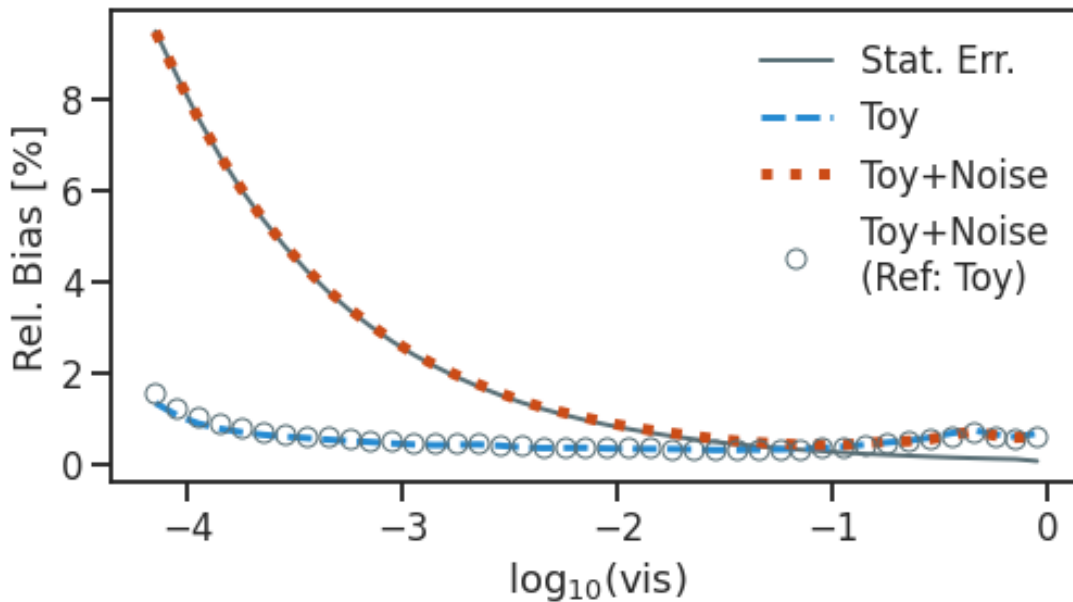

## Toy Model

- train SIREN w/ toy model
  - *NO* stat. fluctuation
- compare SIREN output to the analytical model
- $\leq 1\%$  bias
- *systematic* error for SIREN

# SIREN Performance w/ Statistical Uncertainty

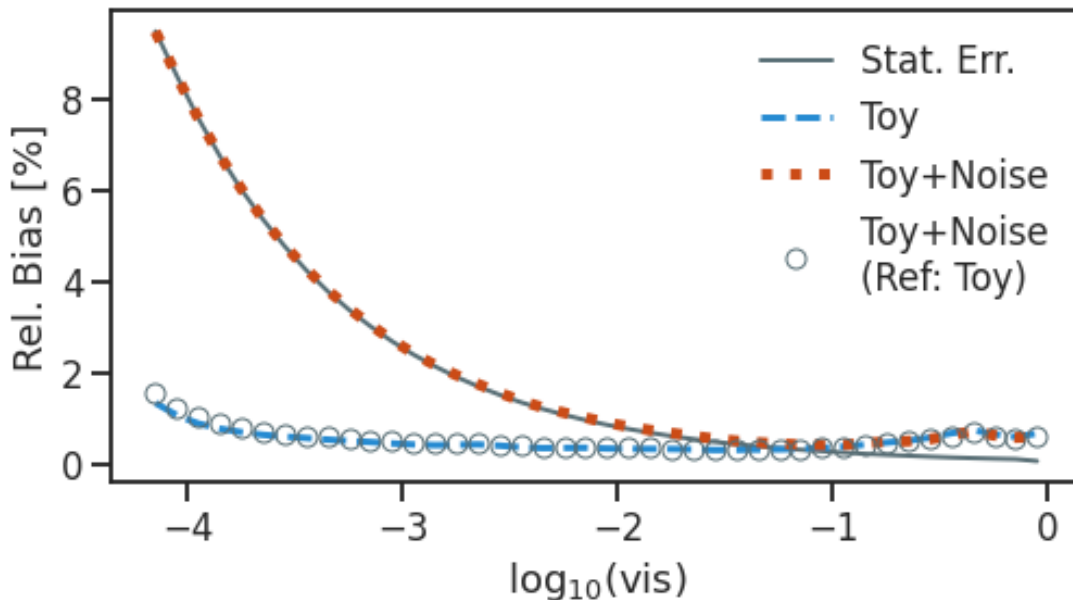

## Toy+Noise Model

- train SIREN w/ toy+model
  - input data *with* stat. fluctuation
- compare SIREN output to the *input data*
- $\leq 1\%$  bias at high visibility values
- bias increases gradually for lower visibility
  - comparable to the expected stat. err.
- contributions from both *statistical* and *systematic*

# SIREN Performance

## Learning the Underlying Distribution

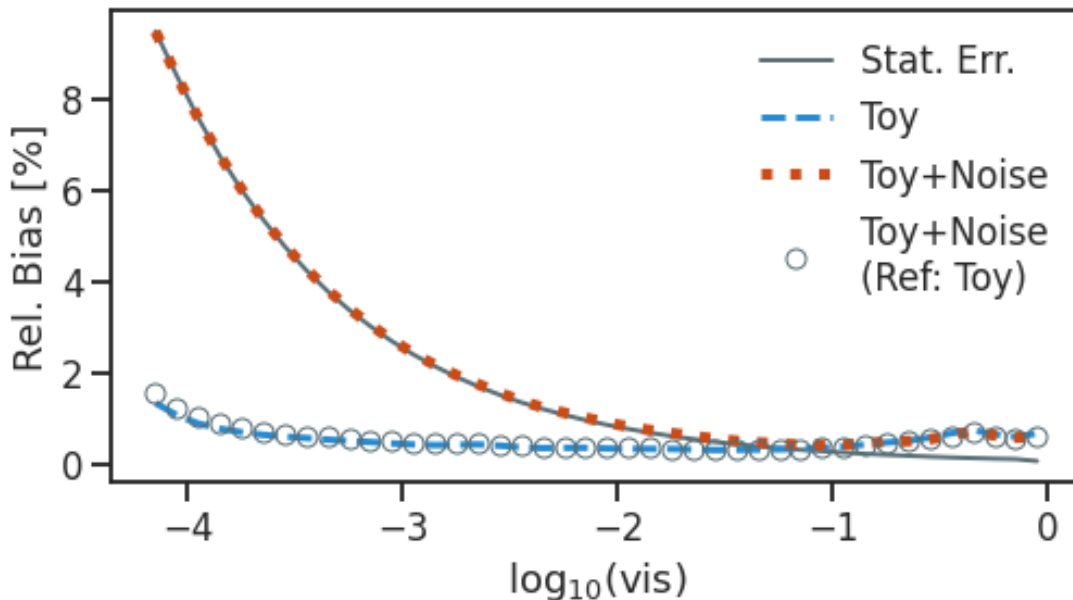

### Toy+Noise Model (Ref: Toy)

- train SIREN w/ toy+model
  - input data *with* stat. fluctuation
- compare SIREN output to the *analytical model (i.e. the truth distribution)*
- same bias as trained with Toy Model (i.e. input data w/o stat. uncertainty)
- statistical fluctuations suppressed

SIREN is able to learn the underlying distribution at  $\leq 1\%$  level, even with the imperfect input data.

# Case 1: LUT == 0, SIREN high vis.

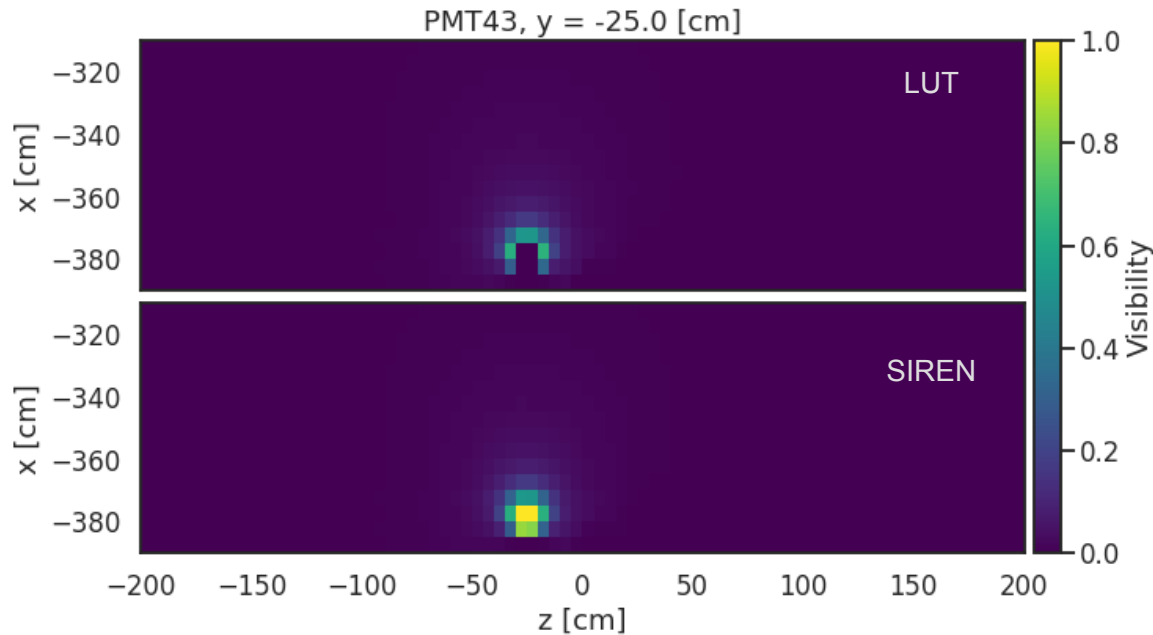

No light at the base / mount of PMT.

SIREN (as a continuous parameterization) tries to map the visibility toward max. visibility = 1.

**Negligible impact on physics.** It corresponds track hitting directly to the PMT, leaving *NO* ionization charge. Likely there is a fiducial volume in the high level analysis.



# Case 2: SIREN Overpredicts Visibility

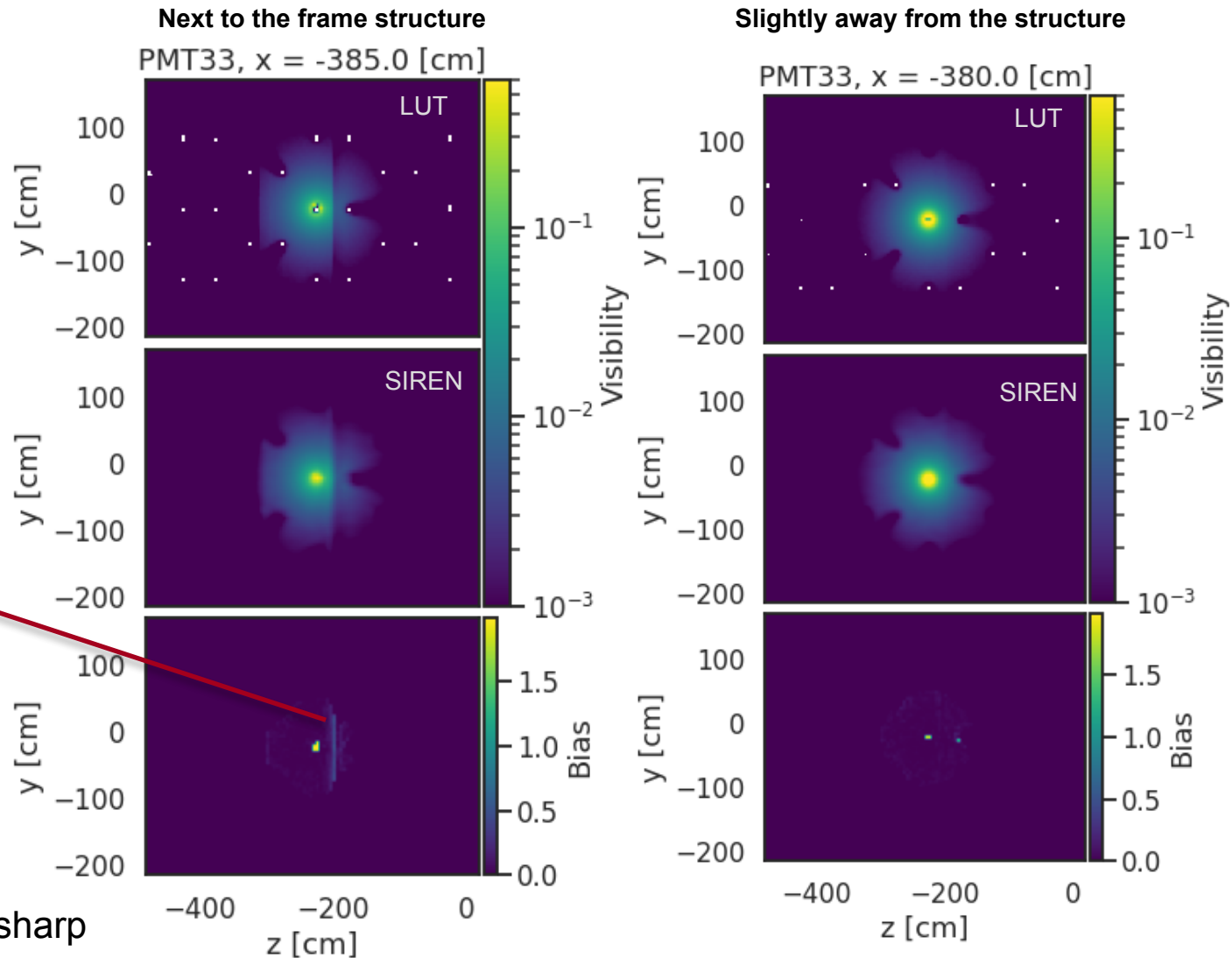

SIREN's limitation on sharp edge transition.

# Module-0 Detector

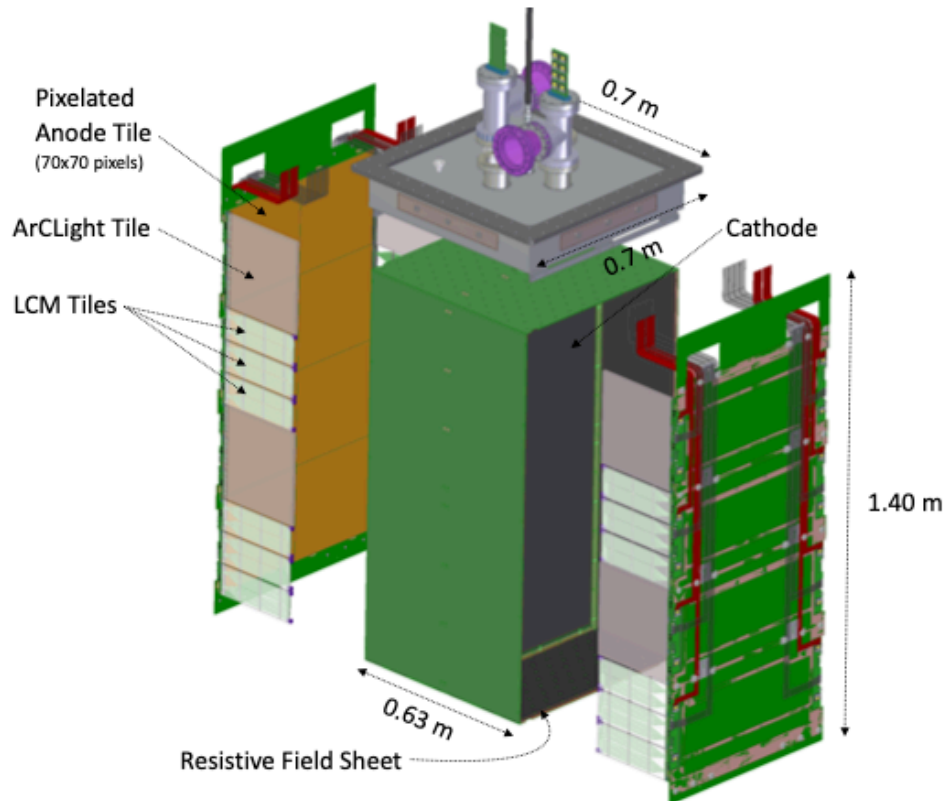

## Short term goal

- build a prototype of 2x2 array of detector modules
- test w/ NuMI neutrino beam at Fermilab

## Long term goal

- build a 7x5 array (TBC) for the DUNE Liquid Argon Near Detector

**Figure 1.** Schematic of the 0.7 m × 0.7 m × 1.4 m Module-0 detector with annotations of the key components.

# Module-0 Charge Readout System

View from the top of Module-0

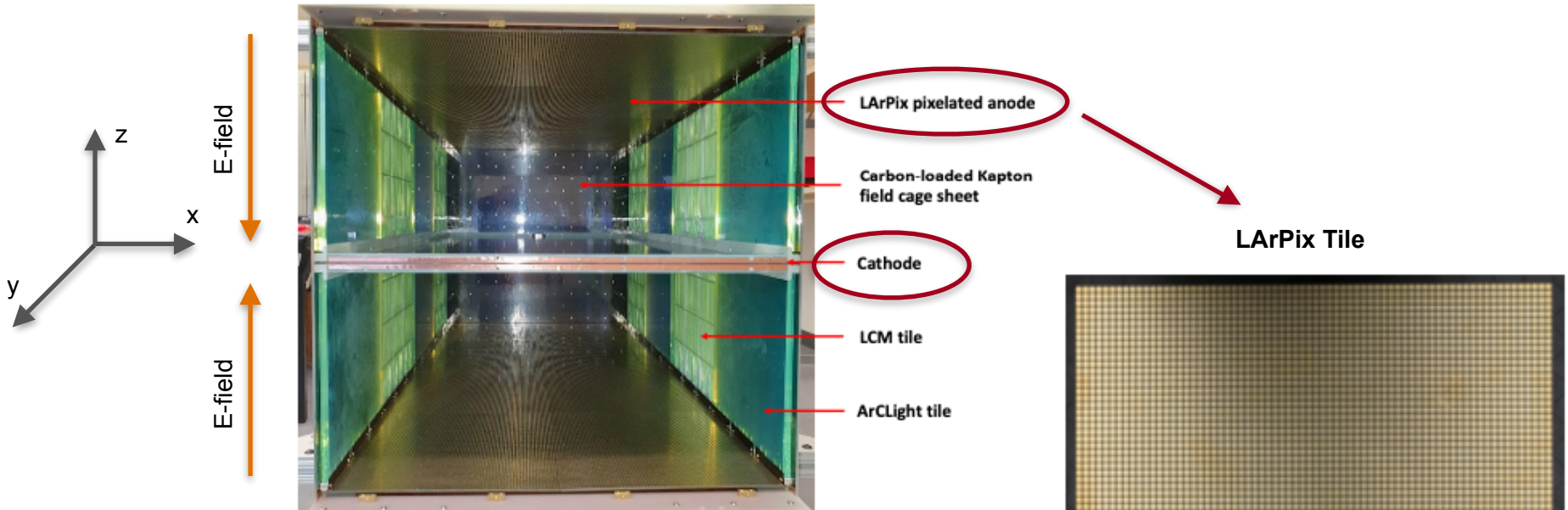

- 2 drift volumes (TPCs)
- separated by a cathode plane
- 4x2 LArPix tiles per anode plane
- 70x70 pixels per tile
- pixel pitch 4.43 mm

# Module-0 Light Readout System

Light Readout System of Module-0

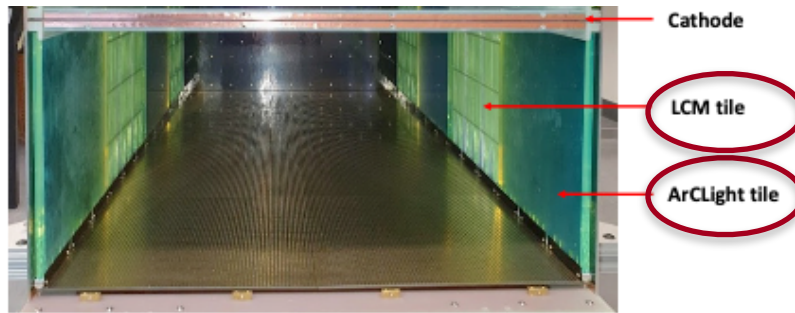
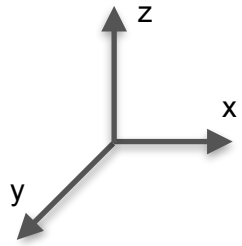

ArCLight tile

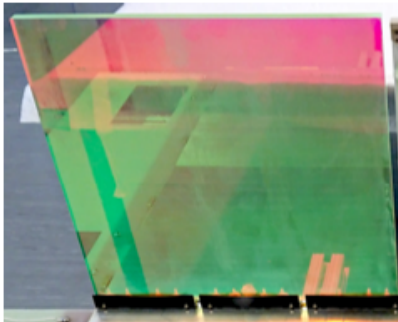

↓ ↓ ↓ ↓ ↓ ↓  
6 SiPMs

LCM tile



↓ ↓ ↓ ↓ ↓ ↓  
2 SiPMs 2 SiPMs 2 SiPMs

- 4 LCM and 4 ArCLight tiles per TPC
- each tiles ~300 mm x 300 mm x 10 mm
- 6 SiPMs per tile
- total of 48 SiPMs per TPC

# Data Selection for Module-0

- data collected between 4/4/21 - 4/10/21 at Bern
  - “*default*” settings (0.5 kV/cm, med. threshold ....)
- cathode-anode crossing tracks in TPC-0
  - one clustered object per charge image
  - dbscan eps=25 mm, min\_samples=5
- matching charge-light pairs by trigger timestamp
- ~680k tracks selected
  - training/validation/testing samples in 75-15-15 splitting ratio
  - for track statistic study, splitting ratio is 20-80 for training/testing

# Note on SiPM Indexing

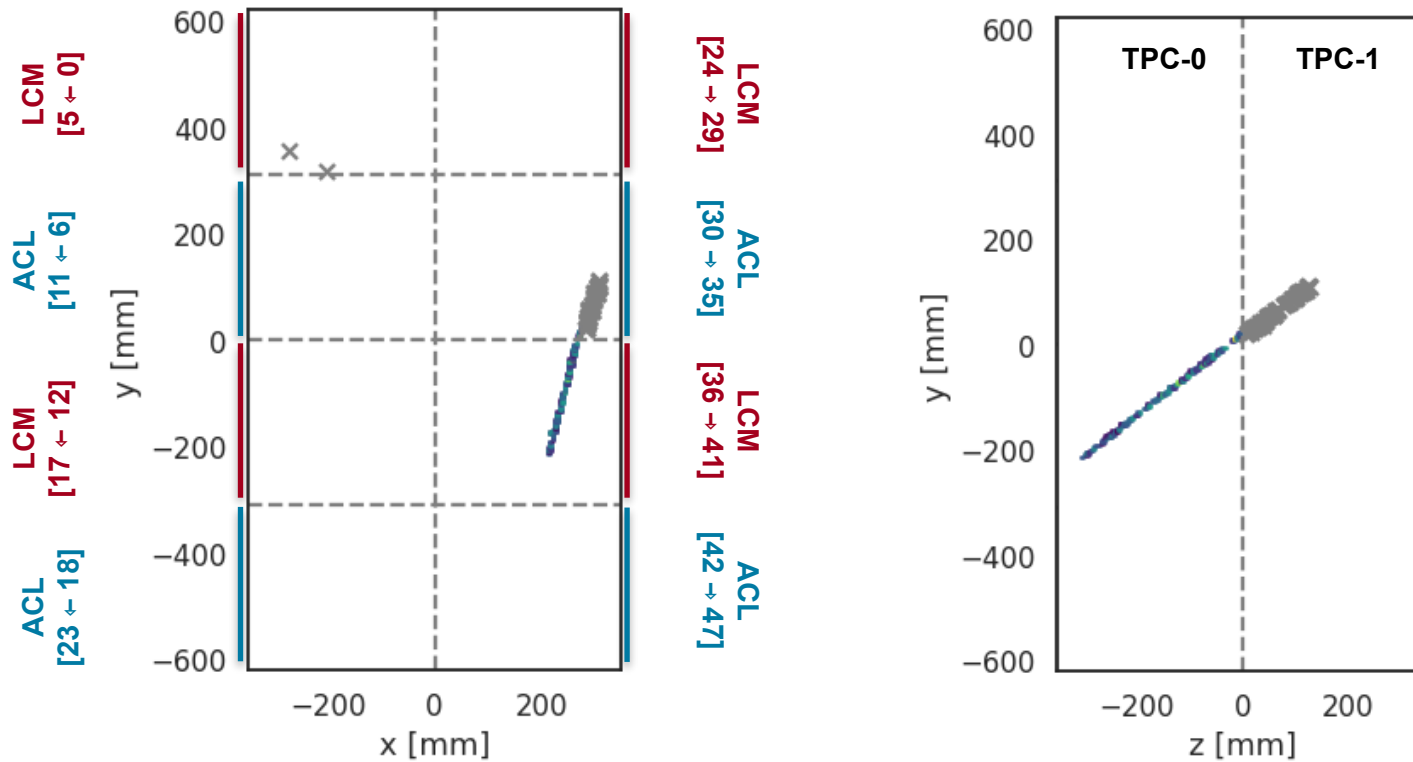

\*\* Grayed out points are excluded from this analysis

- unclustered points, or
- portion of track in TPC-1

# Charge-to-Light: SIREN v.s. LUT

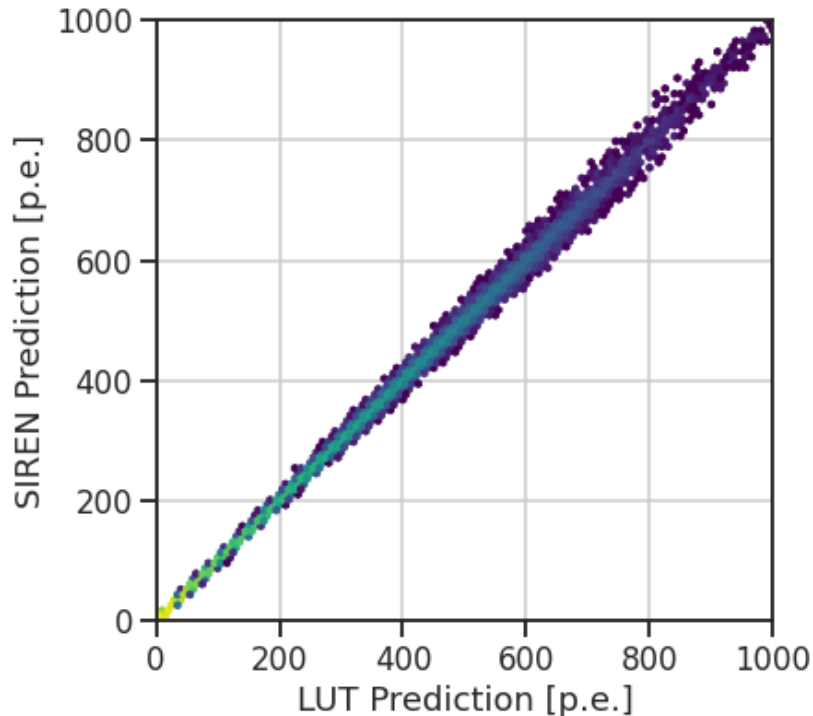

- train a SIREN model using simulated data (i.e. LUT)
- point-source input
  - $\{x_i, y_i, z_i\} \rightarrow \{\text{vis}_i^0, \text{vis}_i^1, \dots, \text{vis}_i^{47}\}$
- calculate charge-to-light prediction
  - $\text{pred.} \sim \sum Q_i \text{vis}(r_i)$
- $\text{vis}(r_i)$ : either from LUT or SIREN
- both methods are practically the same <<1% difference

# Calibration of SIREN Model

Calibration => Multi-parameters optimization problem of the SRIEN model

**Objective** minimize the difference between observation and prediction

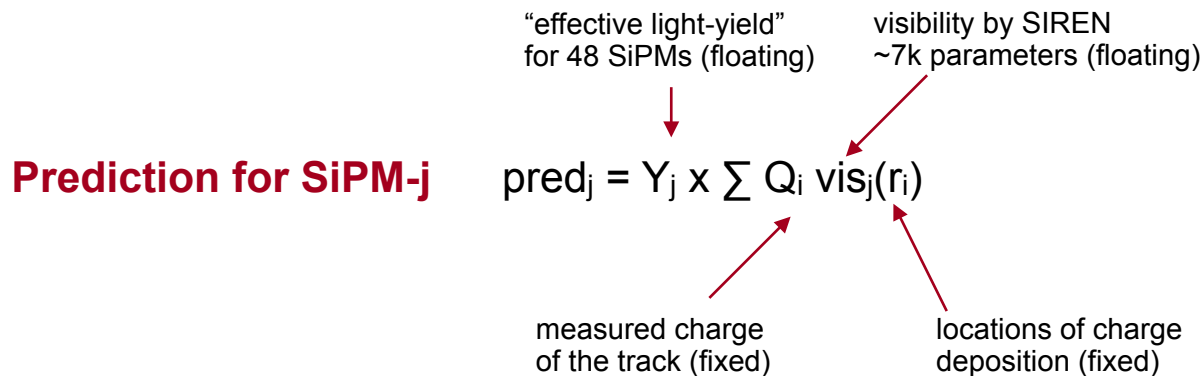

**Loss function**  $\chi^2 = \sum_j (\text{obs}_j - \text{pred}_j)^2 / (\text{pred}_j + \epsilon^2)$

$\epsilon = 5 \text{ p.e.}$